

# AKAI

## Clockradio/CD-player

ARC120



User manual

GB 2

Gebruiksaanwijzing

NL 15

Manuel de l'utilisateur

FR 29

Manual de instrucciones

ES 43

Gebrauchsanleitung

DE 57

Οδηγίες χρήσεως

EL 71

## Table of contents

<b>1.</b>	<b>Safety</b> .....	<b>3</b>
	1.1 Intended use .....	3
	1.2 Labels in this manual .....	3
	1.3 General safety instructions .....	3
<b>2.</b>	<b>Preparations for use</b> .....	<b>4</b>
	2.1 Unpacking .....	4
	2.2 Package contents .....	4
<b>3.</b>	<b>Installation</b> .....	<b>5</b>
	3.1 Battery backup .....	5
<b>4.</b>	<b>Functions</b> .....	<b>7</b>
	4.1 Clockradio/CD player .....	7
<b>5.</b>	<b>Operation</b> .....	<b>9</b>
	5.1 Set the time.....	9
	5.2 Clock functions.....	9
	5.3 Alarm function .....	10
	5.4 Radio functions .....	10
	5.5 CD functions .....	11
<b>6.</b>	<b>Cleaning and maintenance</b> .....	<b>12</b>
	6.1 Handle and care of a disc .....	12
<b>7.</b>	<b>Troubleshooting</b> .....	<b>13</b>
<b>8.</b>	<b>Technical data</b> .....	<b>13</b>
<b>9.</b>	<b>Disposal of used electrical and electronic equipment</b> .....	<b>14</b>

## Copyright notice

Design and specifications are subject to change without notice.

# 1. Safety

## 1.1 Intended use

The Clockradio/CD player wakes you up with music from CD or radio broadcast. The clock function includes an alarm and sleep program. Read the manual carefully before the first use.

## 1.2 Labels in this manual



### WARNING

A warning means that injury or death is possible if the instructions are not obeyed.



### CAUTION

A caution means that damage to the equipment is possible.



A note gives additional information, e.g. for a procedure.

## 1.3 General safety instructions



### WARNING

Do not put force on the appliance. The appliance can fall and can cause serious injury.



### CAUTION

Do not spill any liquid on the appliance.



### WARNING

Do not insert any objects in the ventilation holes.



### CAUTION

Do not block the ventilation holes.



This appliance is double insulated; therefore no earth wire is required. Always check that the mains voltage corresponds to the voltage on the rating plate.



This appliance employs a laser system. To prevent direct exposure to the laser beam, do not open the appliance. Visible laser radiation when open and interlock defeated.

## 2. Preparations for use

### 2.1 Unpacking

- Unpack the appliance carefully.
- Check the package contents as described below. If any item is missing, please contact your reseller.
- Remove the labels from the front panel carefully if present.



We recommend that you retain the original carton and packing materials in case it ever becomes necessary to return your product for service. This is the only way to safely protect the product against damage in transit. If you do dispose of the carton and the packing materials, please remember to recycle with due care to the environment.

### 2.2 Package contents

The following items are included in the received package:

- 1 Clockradio/CD player
- 1 Operator manual



If any item is missing, please contact your reseller.

## 3. Installation

- Put the appliance on a horizontal flat surface.
- Connect the appliance to the mains.



### CAUTION

- Do not put the appliance near a heat source.
- Do not expose the appliance to direct sunlight.



This appliance is equipped with rubber feet to prevent it from moving. The feet are made from non-migrating material specially formulated to avoid leaving any marks or stains on furniture. However, certain types of furniture polishes, wood preservatives or cleaning sprays cause the rubber to soften and leave marks or a residue on the furniture, and potentially risk the surface to become damaged. To prevent damage to wooden surfaces, we recommend that you apply self-adhesive pads to the bottom of the rubber feet before installation.

### 3.1 Battery backup

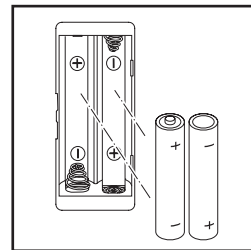
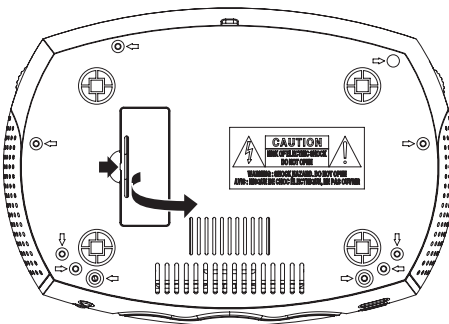

In case of a power failure, the appliance relies on battery backup. For this purpose, the appliance uses two batteries (AAA). The appliance remembers the time, but does not display it.



- Batteries are not included with this appliance.
- Batteries are not necessary for normal operation.

### **Install batteries**

- Remove the battery cover.
- Insert the batteries matching the (+) and (-) polarity markings.
- Re-install the battery cover.



#### **CAUTION**

Incorrect installation can cause battery leakage and corrosion which will damage the appliance. Corrosion, oxidation, battery leakage and any other gradually acidic defect of this nature will invalidate the guarantee.

## 4. Functions

### 4.1 Clockradio/CD player

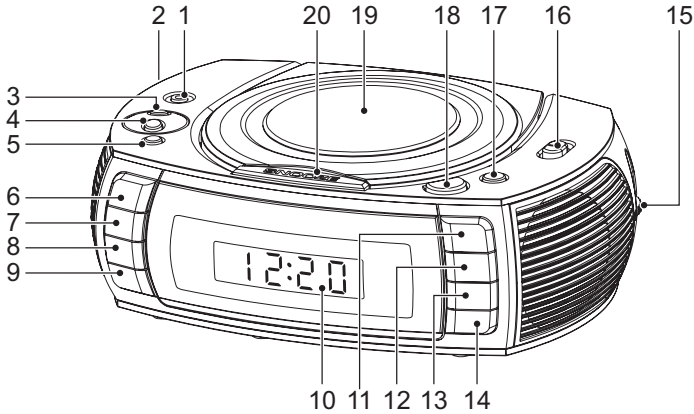

- 1 Headphone jack
- 2 VOLUME dial
- 3 ALARM1 button
- 4 ALARM2 button
- 5 CLOCK ADJ button
- 6 PROGRAM button
- 7 REPEAT/RANDOM button
- 8 DISPLAY button
- 9 SLEEP button
- 10 Display
- 11 PLAY/PAUSE button
- 12 STOP button
- 13 SKIP FORWARD/HOUR button
- 14 SKIP BACKWARD/MINUTE button
- 15 TUNING dial
- 16 FUNCTION switch
- 17 ON/OFF button
- 18 OPEN button
- 19 CD compartment
- 20 SNOOZE button

## Display

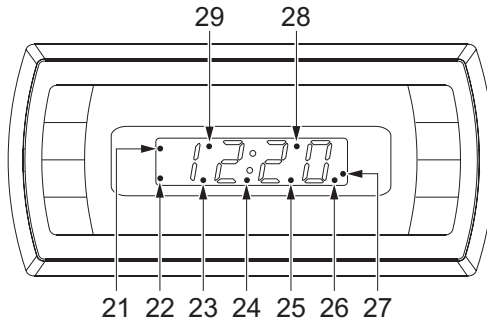

- 21 ALARM1 indicator
- 22 ALARM2 indicator
- 23 SLEEP indicator
- 24 PROGRAM indicator
- 25 REPEAT indicator
- 26 SNOOZE indicator
- 27 PM indicator
- 28 RANDOM indicator
- 29 POWER ON indicator



## 5. Operation

- To switch on the appliance, press the ON/OFF button (17). The POWER ON indicator (29) on the display lights up. To switch off the appliance, press the ON/OFF button (17) again.
- To adjust the volume level, turn the VOLUME dial (2) until the desired level is set.
- To connect a headphone, insert the cable plug in the headphone jack (1). To prevent hearing damage, remember to adjust the volume to a comfortable level.

### 5.1 Set the time

- Connect the appliance to the mains. The default time (12:00) flashes on the display.
- To set the correct hour, press the SKIP FORWARD/HOUR button (13).
- To set the correct minutes, press the SKIP BACKWARD/MINUTE button (14).
- To confirm the setting, press the PROGRAM button (6).
- To switch the clock setting between 12H mode and 24H mode, hold the CLOCK ADJ (5) button for two seconds.



- To set the time, the appliance must be switched off.
- During a power failure, or when unplugging the appliance, the time settings are lost, unless backup batteries are installed.

### 5.2 Clock functions

#### Setting the SLEEP function

- Select the desired radio station or insert a CD.
- Press the SLEEP button (9). The SLEEP indicator (23) is ON.
- To adjust the sleep time, press the SLEEP button (9) until the desired period is set (90/60/30/15 minutes). The appliance stops playing after the chosen time has elapsed.
- To cancel the SLEEP function, press the ON/OFF button (17).

## 5.3 Alarm function

This function is available in CD, AM/FM and BUZZER mode. Two time slots are available (ALARM1 and ALARM2).

- Switch the appliance off.
- Slide the FUNCTION switch (16) to the desired position (CD, AM/FM or BUZZER). Adjust the volume.
  - For AM/FM alarm, tune to the desired radio station
- Press the ALARM1 button (3) to set ALARM1. The clock display flashes.
- Press the HOUR and MINUTE buttons (13 and 14) to set the desired time, and press the ALARM1 button to confirm the setting. The ALARM1 indicator (21) is ON.
- Press the ALARM2 button (2) to set ALARM2. The clock display flashes.
- Press the HOUR and MINUTE buttons (13 and 14) to set the desired time, and press the ALARM2 button to confirm the setting. The ALARM2 indicator (22) is ON.
- To cancel the alarm, press the ALARM1 or ALARM2 button once.

### Snooze alarm

The default snooze time is: 6 minutes.

- To snooze the alarm, press the SNOOZE button (20) once. The SNOOZE indicator (26) is ON, and the ALARM indicator flashes. The alarm sounds again after the snooze time has elapsed.
- To stop the alarm, press the ON/OFF button (17). The alarm is automatically set for the next day.

## 5.4 Radio functions

- To select the radio band, slide the FUNCTION switch (16) to the AM or FM position.
- To select a frequency or radio station, turn the TUNING dial (15) until the desired frequency is set.



To improve the reception of the FM frequency, extend the aerial antenna. To improve the reception of the AM frequency, turn the appliance.

## 5.5 CD functions

- To select the CD function, slide the FUNCTION switch (16) to the CD position.
- To insert a CD:
  - Open the appliance with the OPEN button (18).
  - Insert the CD with the label upwards.
  - Close the CD compartment (19).
- Switch on the appliance. The display shows the total number of tracks on the CD for two seconds. After two seconds, the appliance returns to clock display.
- To start playback, press the PLAY/PAUSE button (11) once.

During playback, the following functions are available:

- To show the number of the track that is currently playing, press the DISPLAY button (8).
- To select a track, press the SKIP BACKWARD/MINUTE button (14) or the SKIP FORWARD/HOUR button (13) until the desired track is set.
- To search for a specific point on the disc, hold the SKIP BACKWARD/MINUTE button (14) or the SKIP FORWARD/HOUR button (13) until the point is reached and release the button.
- To pause playback, press the PLAY/PAUSE button (11) once; to resume playback, press the button again.
- To stop playback, press the STOP button (12).

### Using the REPEAT/RANDOM function

This function is available in PLAY and STOP mode.

- Press the REPEAT/RANDOM button (7) once to repeat the current track. The repeat indicator (25) flashes.
- Press the button twice to repeat all tracks on the CD. The repeat indicator (25) is ON.
- Press the button three times to play all tracks in random order. The random indicator (28) is ON. The repeat function is now off.
- Press the button once again to exit the REPEAT function.

### Using the PROGRAM function

To use the PROGRAM function for CD, the playback must be in STOP mode.

- To play a list of tracks (max. 64) in a program, press the PROGRAM button (6).

- Press the SKIP BACKWARD/MINUTE button (14) or the SKIP FORWARD/HOUR button (13) to select a desired track.
- Press the PROGRAM button (6) to confirm the selection. Repeat the previous step to select more tracks and confirm every selection with the PROGRAM button (6).
- Press the PLAY/PAUSE button (11) to start the program.
- To check the program, press the PROGRAM button once during STOP mode. Press the PROGRAM button repeatedly to see all the tracks in the PROGRAM.
- To delete the program before the program starts, press the PROGRAM button and then the STOP button. To delete the program during play, press the STOP button.



A program is also deleted when the CD compartment is opened.

## 6. Cleaning and maintenance



### WARNING

Before performing any cleaning or maintenance, switch off and unplug the appliance.

- Clean the outside of the appliance with a soft cloth. When the appliance is very dirty, dampen the cloth slightly with water and a neutral solution.
- Clean the lens with a camera lens brush/blower (not included) if the lens is dirty.

### 6.1 Handle and care of a disc

- Hold the disc with fingers. Hold the disc outer edge and/or the centre spindle hole. Do not touch the disc surface.
- Do not bend or press the disc. Do not expose the disc to direct sunlight or heating sources.
- Clean the disc surface with a soft, dry cleaning cloth. Wipe the disc surface gently, radially, from centre towards the outer edge.
- Do not apply thinner, alcohol, chemical solvent, or sprays when cleaning. Such cleaning fluids will permanently damage the disc surface.

## 7. Troubleshooting

Trouble	Action
No display	Switch on the appliance. Connect the appliance properly. Select the correct function with the FUNCTION switch (16).
No sound	Connect the appliance properly. Adjust the volume. Adjust tuning control. Check if the CD is inserted with the label upwards. Clean the lens.

## 8. Technical data

Parameter	Value
Voltage	230 V <sub>AC</sub> ~ 50 Hz.
Backup voltage	2 x 1.5 V
Power consumption	12 W
Standby power consumption	2.5 W
Max power output	2 x 0.8 W
Headphones output impedance	32 Ω
Radio bands	AM/FM
Dimensions (W x H x D)	235 x 88 x 155 mm
Weight	1.17 kg

### Frequency range

Parameter	Value
AM radio	1540 - 1600 kHz
FM radio	87.5 - 108 MHz

## 9. Disposal of used electrical and electronic equipment



The meaning of the symbol on the material, its accessory or packaging indicates that this product shall not be treated as household waste. Please, dispose of this equipment at your applicable collection point for the recycling of electrical and electronic equipments waste. In the European Union and Other European countries which there are separate collection systems for used electrical and electronic product. By ensuring the correct disposal of this product, you will help prevent potentially hazardous to the environment and to human health, which could otherwise be caused by unsuitable waste handling of this product. The recycling of materials will help conserve natural resources. Please do not therefore dispose of your old electrical and electronic equipment with your household waste.

For more detailed information about recycling of this product, please contact your local city office, your household waste disposal service or the shop where you purchased the product.

For more information and warranty conditions, please visit: [www.akai.eu](http://www.akai.eu)